	产品名称 Product	ESC-M10B-(2C150+12C10)P插头;ESC-M10B-(2C150+12C10)R插座 ESC-M10B-(2C150+12C10)P plug;ESC-M10B-(2C150+12C10)R receptacle	文件号 File no.	
	产品型号 Model	112010105757;112020106556	版本 Version	A2

ESC-M10B-(2C150+12C10)P 插头
ESC-M10B-(2C150+12C10)R 插座
技术规格书
ESC-M10B-(2C150+12C10)P Plug
ESC-M10B-(2C150+12C10)R Receptacle
Technical Specifications

编制 Prepared by /日期 Date: 戚勇 Qi Yong / 2024.05.28

审核 Reviewed by/日期 Date: 姚杰 Yao Jie / 2024.05.28

批准 Approved by/日期 Date: 于宗海 Yu Zomghai/2024.05.28

表单编号 Form number	部 门 Department	页 码 Page number
J3-7.3-48	车载产品中心 New energy&vehicle division	1 / 10

	产品名称 Product	ESC-M10B-(2C150+12C10)P插头;ESC-M10B-(2C150+12C10)R插座 ESC-M10B-(2C150+12C10)P plug;ESC-M10B-(2C150+12C10)R receptacle	文件号 File no.	
	产品型号 Model	112010105757;112020106556	版本 Version	A2

更改和修订 Changes and revisions

<input type="checkbox"/> 更改 Change <input type="checkbox"/> 修订 Revision	日期 Date	更改或修订主要事项 Change or revision of major matters	修改/修订人 Modifier/ Reviser	批准人 Approver
<input type="checkbox"/> 更改 Change <input type="checkbox"/> 修订 Revision	2023.7.7	新增防护盖订货号、体现产品 BOM Added protective cover part number, reflected product BOM.	费柯儒 Fei Keru	吴洪 Wu Hong
<input type="checkbox"/> 更改 Change <input type="checkbox"/> 修订 Revision	2024.5.28	更新信号区公针及母针外形示意图及明细 Update the outline drawing and details for male and female contacts in the signal area.	戚勇 Qi Yong	于宗海 Yu Zonghai
<input type="checkbox"/> 更改 Change <input type="checkbox"/> 修订 Revision				

发送 Send

序号 NO.	姓名 Name	部门 Department	职务 Position	联系方式 Contact
1				
2				
3				
4				
5				
6				
7				
8				
9				
10				
11				
12				
13				
14				
15				
16				
17				
18				

表单编号 Form number	部 门 Department	页 码 Page number
J3-7.3-48	车载产品中心 New energy&vehicle division	2 / 10

	产品名称 Product	ESC-M10B-(2C150+12C10)P插头;ESC-M10B-(2C150+12C10)R插座 ESC-M10B-(2C150+12C10)P plug;ESC-M10B-(2C150+12C10)R receptacle	文件号 File no.	
	产品型号 Model	112010105757;112020106556	版本 Version	A2

1.产品型号及编码 Model and order no.

1.1.产品明细 Product detail

序号 NO.	产品型号 Product model	产品编码 Order no.	配套数量 Quantity	接触件 (选配) Contacts(Optional)
1	ESC-M10B-(2C150+12C10)P 插头 ESC-M10B-(2C150+12C10)P plug	112010105757	1.	插头—公针 Plug—Male
2	ESC-M10B-(2C150+12C10)R 插座 ESC-M10B-(2C150+12C10)R receptacle	112020106556	1	插座—母针 Receptacle—Female

备注：塑料框架打印内容为框架型号及编码，而非插头或插座的型号及编码。插头、插座订货以上面产品编码为准！

Note: The printed content of the plastic frame is the frame model and code, not the plug or receptacle model and code. For plug and receptacle orders please refer to the Order No. above!

1.2.产品 BOM Product BOM

产品型号 Product model	零件型号 Part model	零件编码 Part no.	配套数量 Quantity
ESC-M10B-(2C150+12C10)P 插头 ESC-M10B-(2C150+12C10)P plug	HDC-HM10B-PM 框架 HDC-HM10B-PM frame	114060300197	1
	HDC-HM2C100-MC 公插芯 HDC-HM2C100-MC male contact	114060102133	1
	HDC-HMD12-MC 针绝缘体 HDC-HMD12-MC pin insulator	114060103192	1
	YG1268 浮动衬套 YG1268 floating bushing	114030900581	4
ESC-M10B-(2C150+12C10)R 插座 ESC-M10B-(2C150+12C10)R receptacle	HDC-HM10B-PF 框架 HDC-HM10B-PF housing frame	114060300198	1
	HDC-HM2C100-FC 母插芯 HDC-HM2C100-FC female contact	114060201999	1
	HDC-HMD12-FC 孔绝缘体 HDC-HMD12-FC socket insulator	114060202822	1

1.3.接触件外形及明细 Crimp contacts outline & detail

选配，单独订购(Optional)

1.3.1.电力区公针外形示意图及明细 Power male contacts outline & detail

表单编号 Form number	部 门 Department	页 码 Page number
J3-7.3-48	车载产品中心 New energy&vehicle division	3 / 10

	产品名称 Product	ESC-M10B-(2C150+12C10)P插头;ESC-M10B-(2C150+12C10)R插座 ESC-M10B-(2C150+12C10)P plug;ESC-M10B-(2C150+12C10)R receptacle	文件号 File no.	
	产品型号 Model	112010105757;112020106556	版本 Version	A2

1.3.1.1.

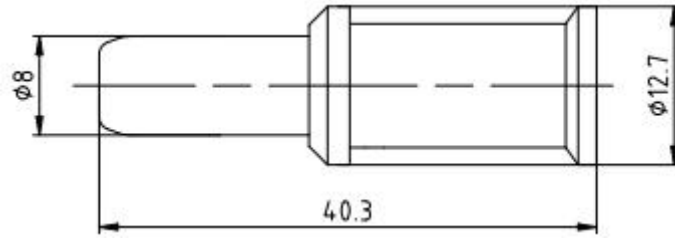

镀层 Plating	产品型号 Product model	产品编码 Order no.	配线规格 Suitable wire	
银 Silver	T80JCS001-T60SC 插针 T80JCS001-T60SC pin	115260034601	6mm ²	AWG9
	T80JCS001-010SC 插针 T80JCS001-010SC pin	115260034602	10mm ²	AWG7
	T80JCS001-016SC 插针 T80JCS001-016SC pin	115260034603	16mm ²	AWG5
	T80JCS001-025SC 插针 T80JCS001-025SC pin	115260034604	25mm ²	AWG3
	T80JCS001-035SC 插针 T80JCS001-035SC pin	115260034605	35mm ²	AWG2
备注:此类型电力公针适用于额定电流 100A 的场景。 Note:This kinds of male contacts are suitable for 100A rated current.				

1.3.1.2.

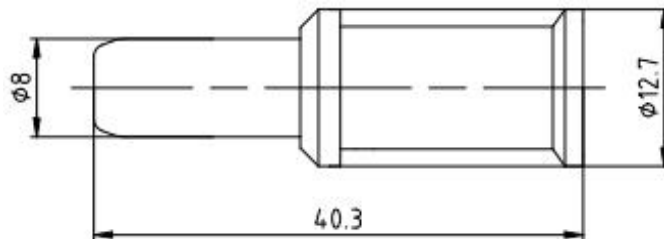

镀层 Plating	产品型号 Product model	产品编码 Order no.	配线规格 Suitable wire	
银 Silver	T80JCS002-025SC 插针 T80JCS002-025SC pin	115260034701	25mm ²	AWG3
	T80JCS002-035SC 插针 T80JCS002-035SC pin	115260034702	35mm ²	AWG2
备注:此类型电力公针适用于额定电流 150A 的场景。 Note:This kinds of male contacts are suitable for 150A rated current.				

表单编号 Form number	部 门 Department	页 码 Page number
J3-7.3-48	车载产品中心 New energy&vehicle division	4 / 10

	产品名称 Product	ESC-M10B-(2C150+12C10)P插头;ESC-M10B-(2C150+12C10)R插座 ESC-M10B-(2C150+12C10)P plug;ESC-M10B-(2C150+12C10)R receptacle	文件号 File no.	
	产品型号 Model	112010105757;112020106556	版本 Version	A2

1.3.2.电力区母针外形示意图及明细 Power female contacts outline & detail

1.3.2.1.

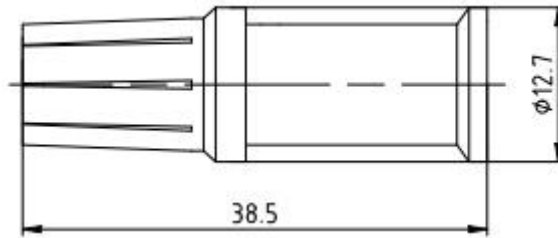

镀层 Plating	产品型号 Product model	产品编码 Order no.	配线规格 Suitable wire	
银 Silver	T80JCB001-T60SC 插孔 T80JCB001-T60SC socket	115360033501	6mm ²	AWG9
	T80JCB001-010SC 插孔 T80JCB001-010SC socket	115360033502	10mm ²	AWG7
	T80JCB001-016SC 插孔 T80JCB001-016SC socket	115360033503	16mm ²	AWG5
	T80JCB001-025SC 插孔 T80JCB001-025SC socket	115360033504	25mm ²	AWG3
	T80JCB001-035SC 插孔 T80JCB001-035SC socket	115360033505	35mm ²	AWG2
备注:此类型电力母针适用于额定电流 100A 的场景。 Note:This kinds of female contacts are suitable for 100A rated current.				

1.3.2.2.

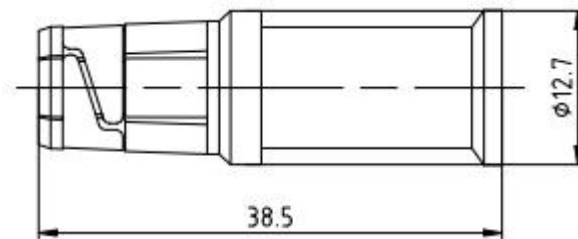

镀层 Plating	产品型号 Product model	产品编码 Order no.	配线规格 Suitable wire	
银 Silver	T80JCB002-025SC 插孔 T80JCB002-025SC socket	115310024701	25mm ²	AWG3
	T80JCB002-035SC 插孔 T80JCB002-035SC socket	115310024702	35mm ²	AWG2
备注:此类型电力母针适用于额定电流 150A 的场景。 Note:This kinds of female contacts are suitable for 150A rated current.				

表单编号 Form number	部 门 Department	页 码 Page number
J3-7.3-48	车载产品中心 New energy&vehicle division	5 / 10

	产品名称 Product	ESC-M10B-(2C150+12C10)P插头;ESC-M10B-(2C150+12C10)R插座 ESC-M10B-(2C150+12C10)P plug;ESC-M10B-(2C150+12C10)R receptacle	文件号 File no.	
	产品型号 Model	112010105757;112020106556	版本 Version	A2

1.3.3.信号区公针外形示意图及明细 Signal male contacts outline & detail

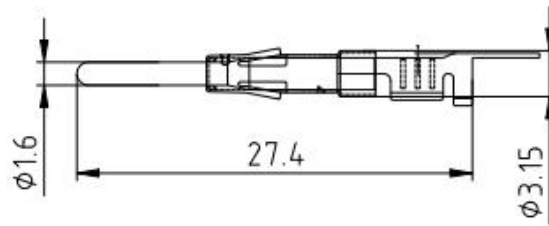

镀层 Plating	产品型号 Product model	产品编码 Order no.	配线规格 Suitable wire	
锡 Tin	T16WAS001-H50GC 插针 T16WAS001-H50GC pin	110010400947	0.34-0.5mm ²	AWG22-20

1.3.4.信号区母针外形示意图及明细 Signal female contacts outline & detail

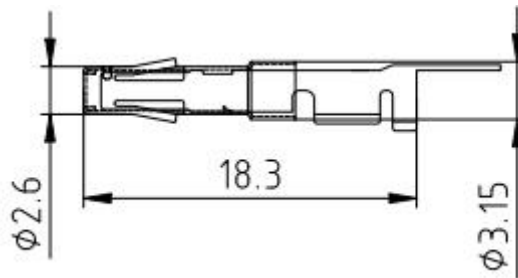

镀层 Plating	产品型号 Product model	产品编码 Order no	配线规格 Suitable wire	
锡 Tin	T16WAB001-H50GC 插孔 T16WAB001-H50GC socket	110010400948	0.34-0.5mm ²	AWG22-20

1.4.防护盖外形示意图及明细 Cover outline & detail

选配, 单独订购(Optional)

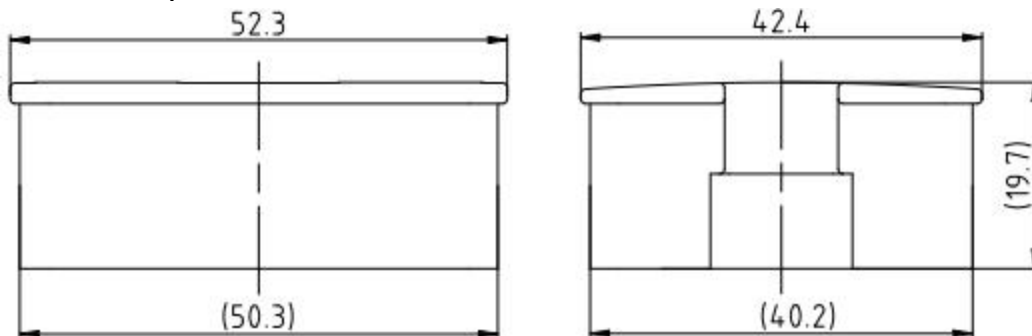

表单编号 Form number	部 门 Department	页 码 Page number
J3-7.3-48	车载产品中心 New energy&vehicle division	6 / 10

	产品名称 Product	ESC-M10B-(2C150+12C10)P插头;ESC-M10B-(2C150+12C10)R插座 ESC-M10B-(2C150+12C10)P plug;ESC-M10B-(2C150+12C10)R receptacle	文件号 File no.	
	产品型号 Model	112010105757;112020106556	版本 Version	A2

产品型号 Product model	产品编码 Order no.
ESC-M10B 防护盖 ESC-M10B protective cover	114069805401

2.技术参数 Specification

2.1 电气特性 Electrical characteristic

模块位数 Number of modules	3	
浮动公差 Floating tolerance	±2mm	
芯数 Pins	2(Max)	12(Max)
适配接触件规格 Fitting contacts	φ8mm	φ 1.6mm
额定电流 Rated current	100A/150A	5A
额定电压 Rated voltage	1500V	250V
耐电压 Voltage proof	6800V AC 50Hz	1500V AC 50Hz
接触电阻 Contact resistance	≤0.3mΩ	≤5mΩ
绝缘电阻 Insulation resistance	≥100M Ω	
温升 Temperature rise	≤45K	

2.2 机械特性 Mechanical characteristics

机械寿命 Durability	≥500 cycles
--------------------	-------------

2.3 材料及表面处理 Material and finish

材料 Material	绝缘体 Insulator: 工程塑料 Engineering plastic 针孔件 Contacts: 铜合金 Copper alloy
表面处理 Surface treatment	镀银 Silver/镀金 Gold

表单编号 Form number	部 门 Department	页 码 Page number
J3-7.3-48	车载产品中心 New energy&vehicle division	7 / 10

	产品名称 Product	ESC-M10B-(2C150+12C10)P插头;ESC-M10B-(2C150+12C10)R插座 ESC-M10B-(2C150+12C10)P plug;ESC-M10B-(2C150+12C10)R receptacle	文件号 File no.	
	产品型号 Model	112010105757;112020106556	版本 Version	A2

阻燃等级 Flame rating	UL94 V0
-------------------	---------

2.4 工作环境 Operating environment

工作温度 Operating temperature	-40°C ~ +125°C
振动 Vibration/冲击 Shock	GB/T 21563-2018 Class 1 Level B

3.物料简介 Introduction

线径范围 Cable range	6mm ² -35mm ² / 25mm ² -35mm ²	0.14mm ² -2mm ²
端接方式 Termination mode	冷压 Crimp termination	
安装方式 Installation method	螺钉(M4) Screw(M4)	
安装扭矩 Installation torque	2±0.2N•m	

3.1.执行标准 According to standards: IEC61984、IEC60664-1、GB/T21563

3.2.环保信息 Environment protect data: RoHS2.0

3.3.安规信息 Security authentication: CE、UL

4.外形尺寸 Outline dimension

4.1 产品外形 Product outline:

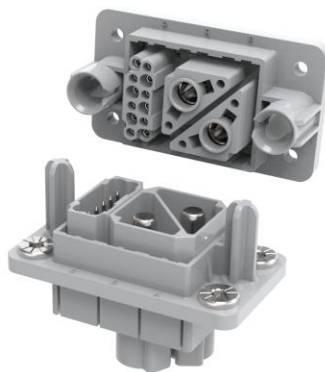

表单编号 Form number	部 门 Department	页 码 Page number
J3-7.3-48	车载产品中心 New energy&vehicle division	8 / 10

	产品名称 Product	ESC-M10B-(2C150+12C10)P插头;ESC-M10B-(2C150+12C10)R插座 ESC-M10B-(2C150+12C10)P plug;ESC-M10B-(2C150+12C10)R receptacle	文件号 File no.	
	产品型号 Model	112010105757;112020106556	版本 Version	A2

4.2 产品外形尺寸 Product outline dimension

4.2.1 插头外形尺寸 Plug outline dimension

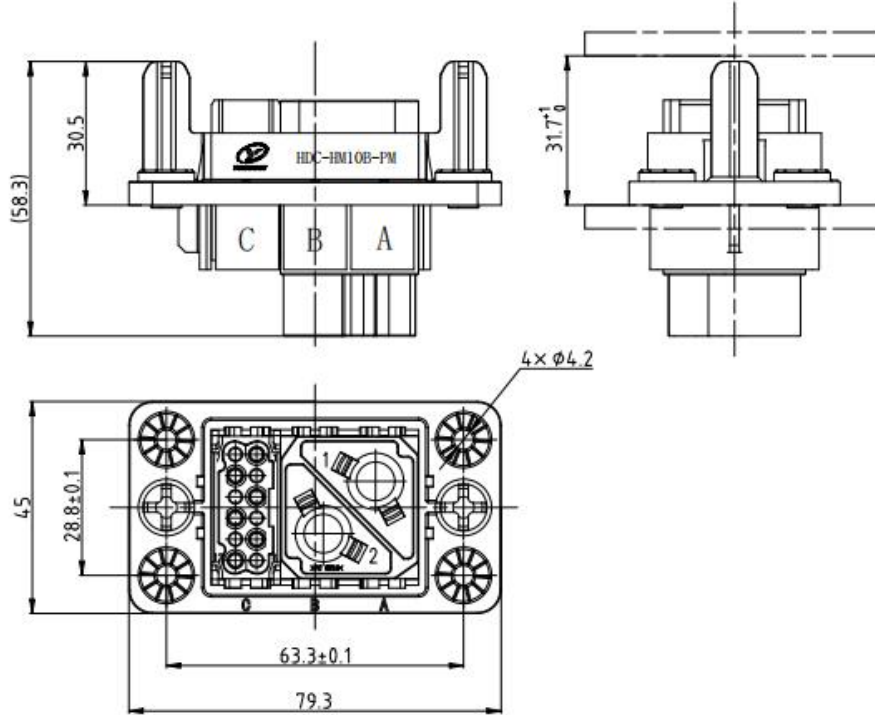

4.2.2 插座外形尺寸 Receptacle outline dimension

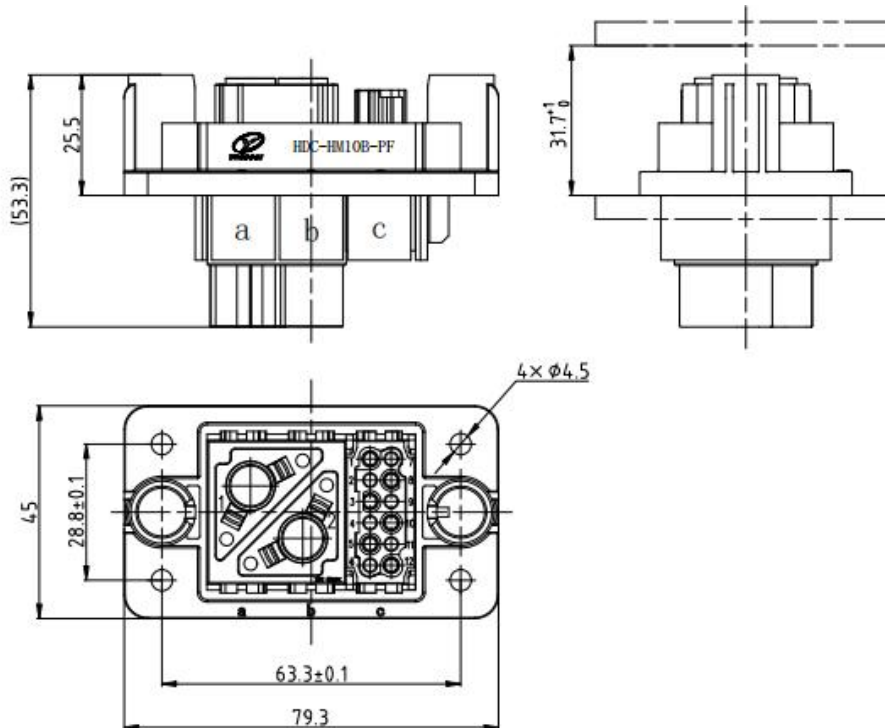

表单编号 Form number	部门 Department	页码 Page number
J3-7.3-48	车载产品中心 New energy&vehicle division	9 / 10

	产品名称 Product	ESC-M10B-(2C150+12C10)P插头;ESC-M10B-(2C150+12C10)R插座 ESC-M10B-(2C150+12C10)P plug;ESC-M10B-(2C150+12C10)R receptacle	文件号 File no.	
	产品型号 Model	112010105757;112020106556	版本 Version	A2

4.2.3.安装开孔尺寸 Installing holes dimension

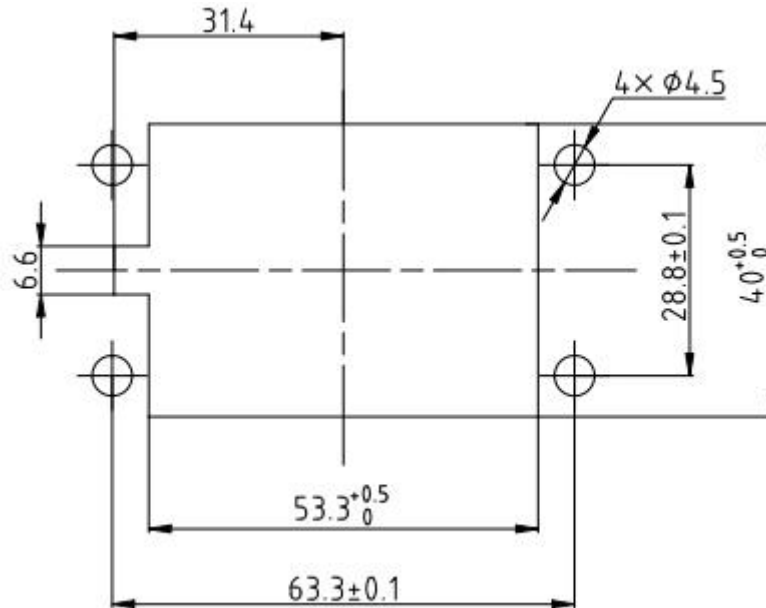

5.说明及包装存储 Description and packaging storage

5.1.连接器应在提供的技术参数范围内使用。

Connectors should be used within the specification that provided.

5.2.包装规范 Package spec: 纸箱包装, 防潮处理。

Carton packaging, moisture-proof treatment.

5.3.存储要求 Storage spec:

包装成箱的产品应在环境温度-10°C ~ +40°C, 相对湿度 80%以下, 周围空气中无酸性, 碱性或其它腐蚀性气体的库房里贮存, 贮存期自生产日期不超过两年。

The packaged products shall be stored in the warehouse within the temperature of -10 °C ~ + 40 °C, relative humidity less than 80%, and no acid, alkaline or other corrosive gases in the surrounding air. The storage period shall not exceed two years from the production date.

表单编号 Form number	部 门 Department	页 码 Page number
J3-7.3-48	车载产品中心 New energy&vehicle division	10 / 10